

REFERENCE CHANTIER

Date

DEMANDE DE PRIX

COMMANDE

TYPE MENUISERIE ⇔

58 } Recouvrement  
 68 }

58 } Traditionnel  36 sous mastic  
 68 }

ESSENCE ⇔

Bois exotique rouge

Chêne

Mélèze

Pin

FINITION ⇔

Prépeint blanc

Egalisateur IFH

Lazure

RAL ⇔ int  ext

MOULURATION ⇔

Pente 45° ext\_Doucine int

Doucine

Pente 15°

1/4 de rond  Autre (joindre croquis)

TYPE DE COTES ⇔

Hors-tout

Tableau

Passage (rénovation)

PETITS BOIS ⇔

Collés

Mortaisés

Incorporés

Collés + fictif

Phonique: db ⇔   
RW+CTR

PANNEAUX ⇔

Plate bande

Table saillante

Autre (joindre croquis)

CREDIT D'IMPOT

COMMENTAIRES:

Repères	Hauteur A	Largeur B	Hauteur C	Allège	Repères	Hauteur A	Largeur B	Hauteur C	Allège
	Vitrage ⇔					Vitrage ⇔			
Quantité	Tapées persiennes	ET:	Isolation ⇔	Ep:	Quantité	Tapées persiennes	ET:	Isolation ⇔	Ep:
	VMC ⇔	<input type="checkbox"/> 15 m <sup>3</sup> /h	<input type="checkbox"/> 30 m <sup>3</sup> /h	<input type="checkbox"/> 45 m <sup>3</sup> /h		VMC ⇔	<input type="checkbox"/> 15 m <sup>3</sup> /h	<input type="checkbox"/> 30 m <sup>3</sup> /h	<input type="checkbox"/> 45 m <sup>3</sup> /h
Observation / Croquis (vue intérieure)					Observation / Croquis (vue intérieure)				

Repères	Hauteur A	Largeur B	Hauteur C	Allège	Repères	Hauteur A	Largeur B	Hauteur C	Allège
	Vitrage ⇔					Vitrage ⇔			
Quantité	Tapées persiennes	ET:	Isolation ⇔	Ep:	Quantité	Tapées persiennes	ET:	Isolation ⇔	Ep:
	VMC ⇔	<input type="checkbox"/> 15 m <sup>3</sup> /h	<input type="checkbox"/> 30 m <sup>3</sup> /h	<input type="checkbox"/> 45 m <sup>3</sup> /h		VMC ⇔	<input type="checkbox"/> 15 m <sup>3</sup> /h	<input type="checkbox"/> 30 m <sup>3</sup> /h	<input type="checkbox"/> 45 m <sup>3</sup> /h
Observation / Croquis (vue intérieure)					Observation / Croquis (vue intérieure)				

**MOULURATION**

Pente 45° ext / Doucine int

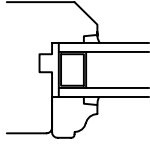

Doucine

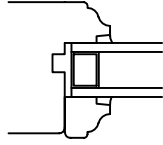

Pente 15°

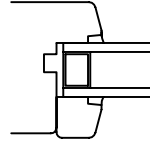

1/4 de rond

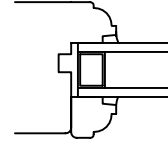

**TYPE DE COTES**

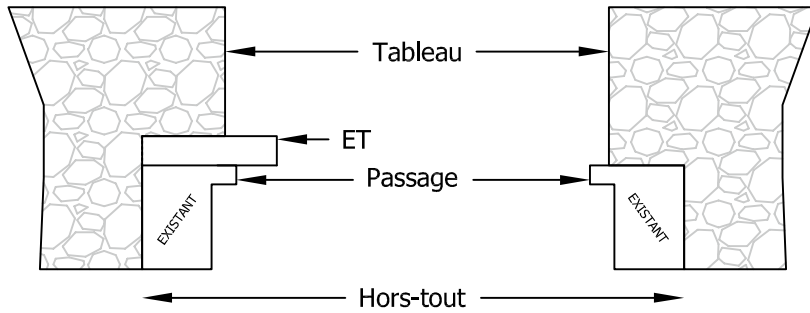
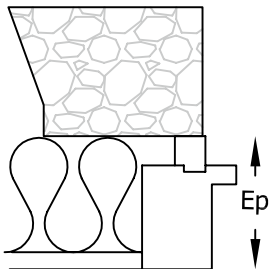
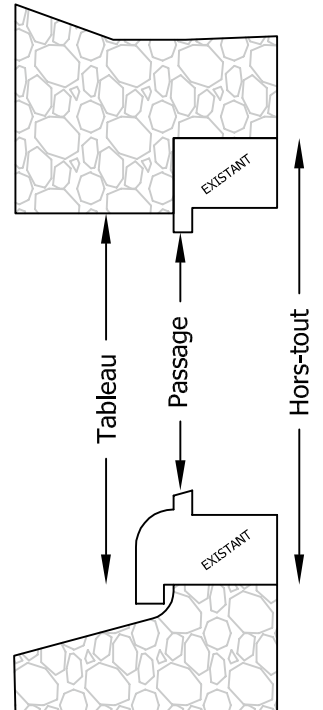
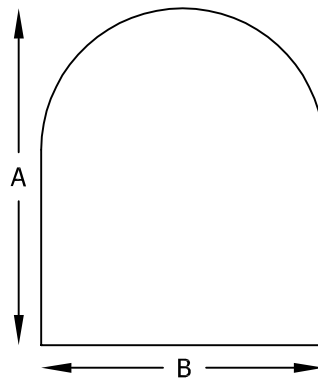
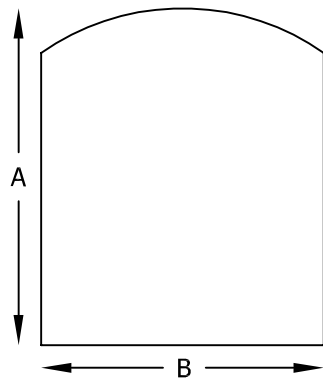
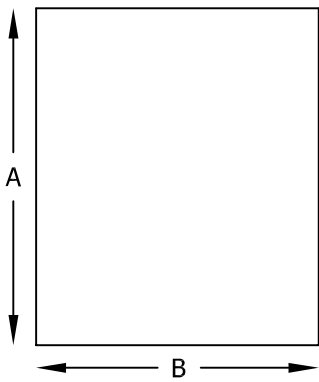

**PETITS BOIS**

Collés

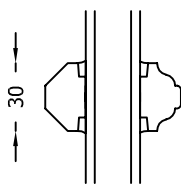

Mortaisés

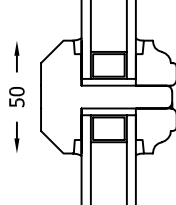

Collés + fictif

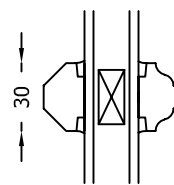

Incorporés

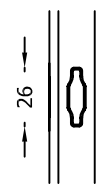

**PANNEAUX**

Plate bande

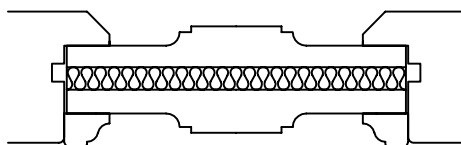

Table saillante

